

# Warranty Information

PASGO faucet warrants the original purchase (must have prove of purchase) that such product is free from defect in materials or workmanship for as long as the original consumer purchaser owns their home from the date of purchase. This warranty is limited to but not including labor charges incurred in/or damages sustained during installation, repair or replacement, nor incidental or consequential damages. This warranty does not cover items which are received secondary finishing or have been altered or modified after purchase, or for defects raised by physical abuse to or misuse of the product. This warranty gives the original purchaser of a PASGO faucet specific legal rights which may vary from state to state or from province to province. In some states or provinces the exclusion or limitation incidental or consequential damages is not allowed, for those exclusions may not apply to you.

Thank you for your purchase

Proposition 65: For more information: [www. P65WARNIGS.CA.GOV](http://www.P65WARNIGS.CA.GOV)

**PASGO**<sup>®</sup>

Kitchen & Bath



Product model: 15318Q

## Tools you may need



Plumbers Tape

Safety Glasses

Phillips Screwdriver

Wrench

Silicone sealant

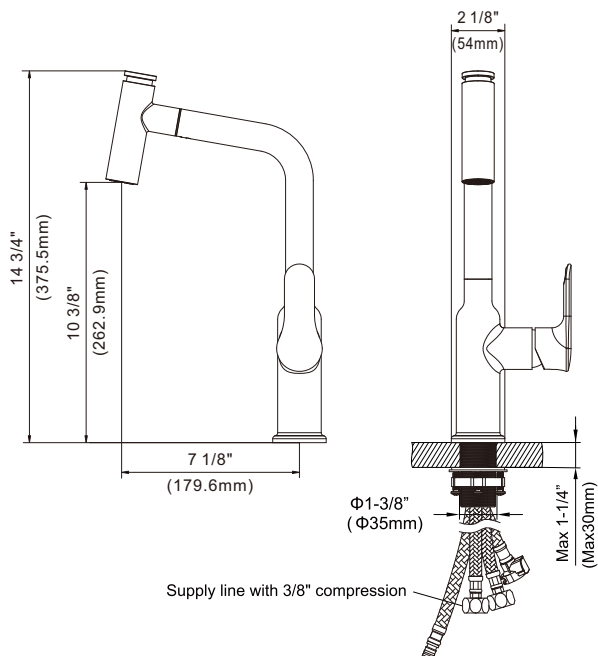

## Dimensions

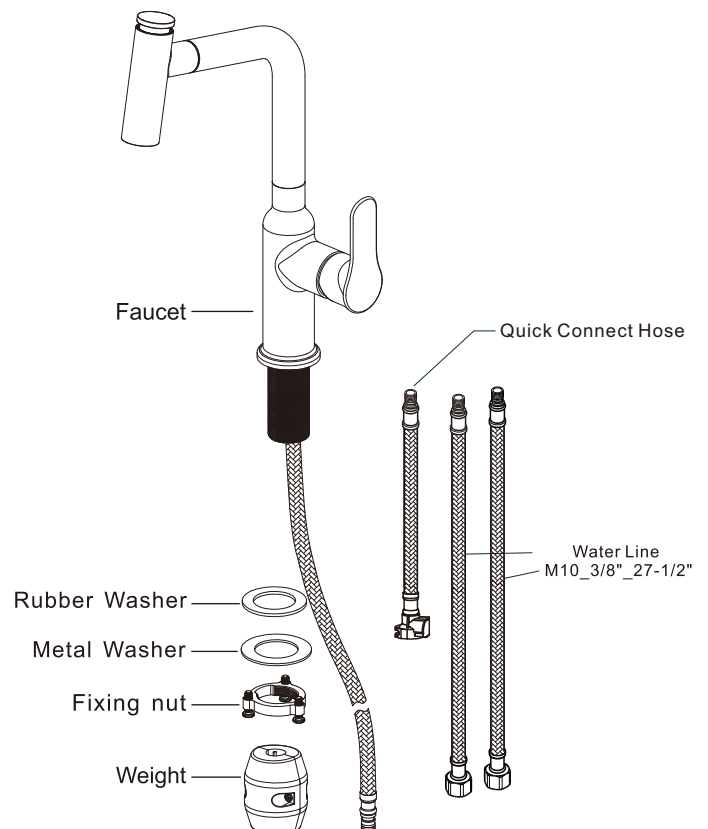

## Parts Diagram

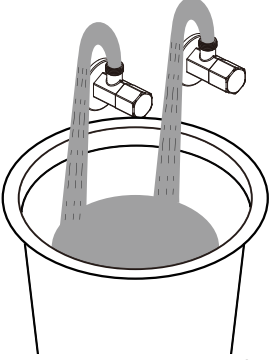
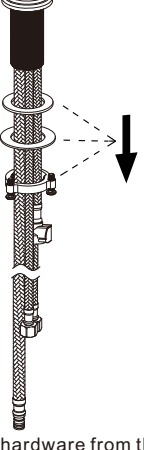
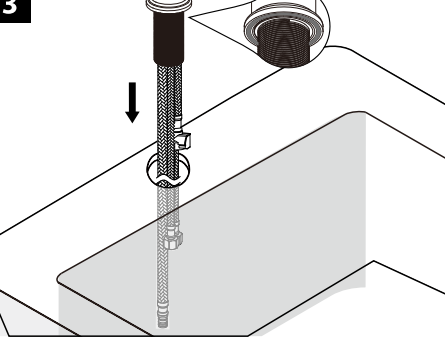

## FAUCET INSTALLATION STEPS

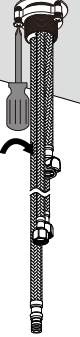
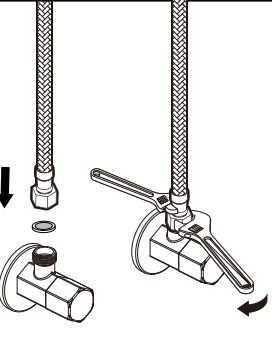
<p><b>1</b></p>  <p>Shut off water suppliers. Remove the old faucet, clean the mounting surface. <b>Note: For first time install, flush the pipes first by open the angle valve to run 60S.</b></p>	<p><b>2</b></p>  <p>Remove the mounting hardware from the mounting pipe.</p>	<p><b>3</b></p>  <p>Put the rubber O-ring into the bottom gap of faucets then Insert faucet into faucet hole.</p>
<p><b>4</b></p> 	<p><b>5</b></p>  <p>Adjust position of faucet body if necessary, Then tighten the mounting nuts with phillips screwdriver until snug.</p>	<p><b>6</b></p>  <p>Connect and tighten the supply hoses by using two adjustable wrenches (avoid twisting or kinking). <b>Note: Do not remove the net filter that attached into the connecting end!</b></p>

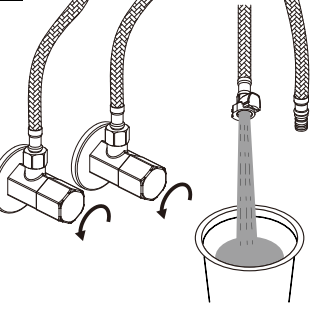
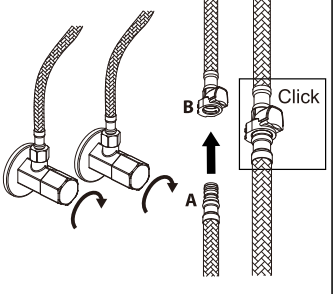
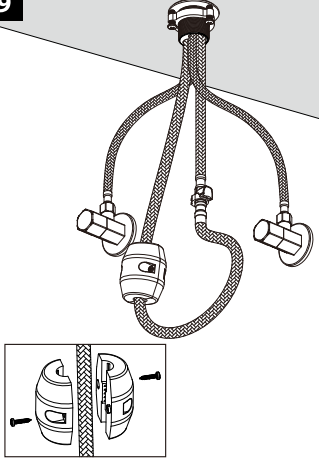
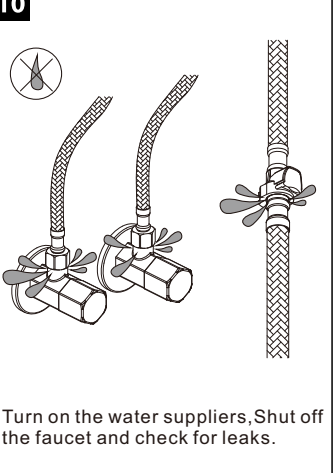
<p><b>7</b></p>  <p>Turn on water suppliers. Place a bucket below outlet tube, slowly open and close the supply angle valves, <b>This will prevent debris from being lodged in the hose and sprayer.</b></p>	<p><b>8</b></p>  <p>Shut off water suppliers. Push the handsprayer hose (A) into the quick (B) until you hear a click sound. Make sure it's secured.</p>
<p><b>9</b></p> 	<p><b>10</b></p>  <p>Turn on the water suppliers, Shut off the faucet and check for leaks.</p>

### Using explanation

Upturn the handle to open the water.  
The larger the angle is, the larger the flow is. Reset is closed.  
Turn left the handle, more cold water:  
Turn right the handle, more hot water  
The spout can be 360 degree rotated.

